

Air Circuit Ideas
Conserve Energy p|22

Hose Testing Ensures
Reliability and Longevity p|30

Prevent Rod Buckling
in Hydraulic Cylinders p|34

JOHN B. LACSON

Hydraulics & Pneumatics®

THE AUTHORITY ON FLUID POWER TECHNOLOGY AND ITS CONTROL

hydraulicspneumatics.com MARCH 2017

FILTERS HELP

MIX IT UP

p|28



S00015
0002

CARSON CA 90745-1339
2131 MARBELLA AVE
B SOMBORIO

MARIFE VARGAS



#BXNPFZH *****FIRM 90745
#975975012 9 # HL 006 221 SEP17 C

Motion Control:
Transmission
Comparisons
P / 18

In This Issue

FEATURES

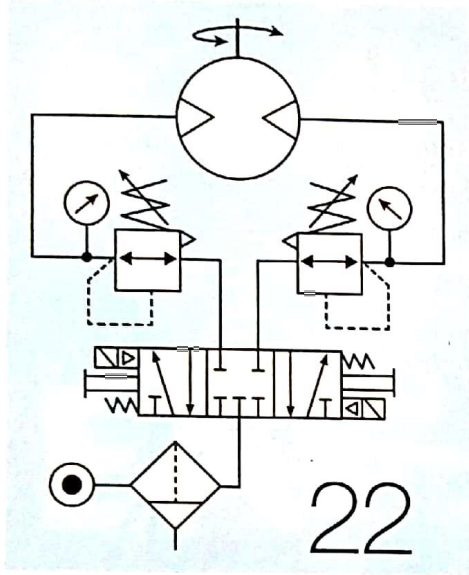

22 SIMPLE CIRCUITS PROVIDE BIG BENEFITS
Strategic use of valves and pressure regulators can improve machine efficiency without sacrificing productivity.

28 FLUID FILTRATION PROTECTS MOBILE CONCRETE MIXER'S HYDRAULIC CONTROL SYSTEM
High-pressure filters protect the sensitive electrohydraulic components in a mobile concrete mixer that delivers concrete compositions fresh to the job site.

30 GUIDELINES FOR CONDUCTING HOSE TESTING
Development engineers and technicians who push hose performance to the limit often conduct tests with hoses installed on original equipment designs. Here is a comprehensive summary of conditions that should be considered.

34 UNDERSTANDING BUCKLING STRENGTH OF HYDRAULIC CYLINDERS
Higher-strength steels not only reinforce hydraulic piston rods against dangerous failures, but yield economic benefits through component downsizing, reduced weight, and cost—without sacrificing safety.

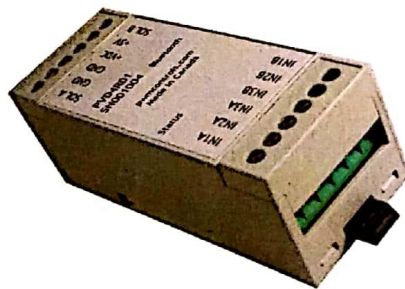
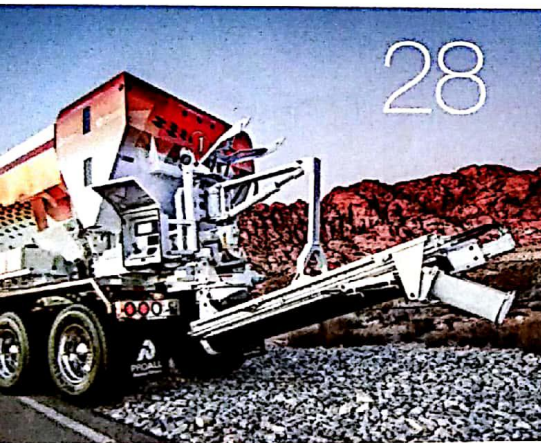

38

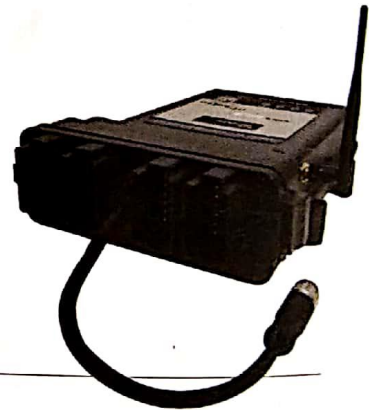

DEPARTMENTS

- | | | | |
|-----------|------------------------------------|-----------|----------------------------------|
| 4 | ON HYDRAULICSPNEUMATICS.COM | 18 | MOTION CONTROL |
| 6 | EDITOR'S PAGE | 38 | USEFUL PRODUCTS |
| 10 | INDUSTRY NEWS | 39 | ADVERTISERS INDEX |
| 12 | IDEAS & APPLICATIONS | 40 | TROUBLESHOOTING CHALLENGE |



JOIN US ONLINE



facebook.com/HydraulicsPneumatics
twitter.com/HPneumatics



THE FPDA
MOTION & CONTROL NETWORK



ISSN 0018-814X
Printed in U.S.A. Copyright © 2017 by Penton Media, Inc., all rights reserved. *Hydraulics & Pneumatics* is published monthly by Penton Media, Inc., 9800 Metcalf Ave., Overland Park, KS 66212-2216. Phone: 216-696-7000. Periodicals postage paid at Kansas City, MO and at additional mailing offices. **POSTMASTER** Send address changes to *Hydraulics & Pneumatics*, 1100 Avenue of the Americas, NY, NY 10036. Copying: permission is granted to users registered with the Copyright Clearance Center Inc. (CCC) to photocopy any article provided base fee of \$1.25 per copy of the article plus 60¢ per page is paid directly to CCC, 222 Rosewood Dr., Danvers, MA 01932 (Code No. 0018-814X/00 \$1.25 + 60¢).

Subscriptions — U.S. and possessions outside U.S.: \$70/yr, \$100/two yrs. Single copy: \$5.00; all other issues \$8.00. In Canada: \$85.00/yr, \$135.00/two yrs. Canada Post Publications Mail Agreement No. 40612608. Canada return address: IMEX Global Solutions, P.O. Box 25542, London, ON, N6C 6B2. International: \$100.00/yr, \$165.00/two yrs. Telephone: 847-763-9670. Fax orders to 847-763-9673. Send subscription payment to: *Hydraulics & Pneumatics*, P.O. Box 2100, Skokie, IL 60076-7800. Out-of-print copies available in microfilm volumes as positive microfilm from NAFCO 800-420-6272 x 6578. Photocopies of articles \$5.00 each. Payment must accompany request. Volume 70, No. 3, March 2017.



AIR SUPREMACY

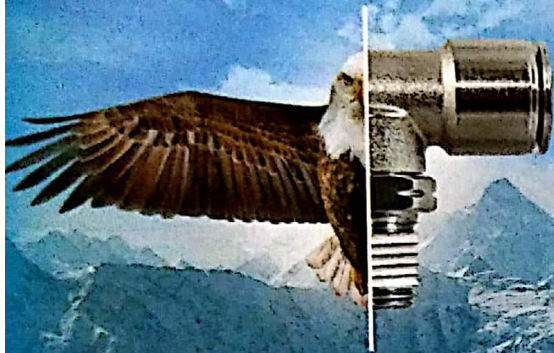

PN LINE
MADE IN ITALY

cmatic.it

EDITORIAL

EDITOR: **ALAN HITCHCOX** alan.hitchcox@penton.com
 CONTENT PRODUCTION DIRECTOR: **MICHAEL BROWNE** michael.browne@penton.com
 CONTENT PRODUCTION SPECIALIST: **ROGER ENGELKE** roger.engelke@penton.com
 PRODUCTION EDITOR: **JEREMY COHEN** jeremy.cohen@penton.com
 CONTENT OPTIMIZATION SPECIALIST: **WES SHOCKLEY** wes.shockley@penton.com
 ASSOCIATE CONTENT PRODUCER: **LEAH SCULLY** leah.scully@penton.com
 CONTRIBUTING EDITOR: **JACK L. JOHNSON** jack@idaseng.com
 CONTRIBUTING EDITOR: **ROBERT J. SHEAF, JR.** rjsheaf@cfc-solar.com

ART & PRODUCTION

GROUP DESIGN DIRECTOR: **ANTHONY VITOLO** tony.vitolo@penton.com
 SENIOR ARTIST: **JIM MILLER** jim.miller@penton.com
 CONTENT DESIGN SPECIALIST: **JOCELYN HARTZOG** jocelyn.hartzog@penton.com
 CONTENT & DESIGN PRODUCTION MANAGER: **JULIE JANTZER-WARD** julie.jantzer-ward@penton.com
 PRODUCTION MANAGER: **SUSAN POSKIN** susan.poskin@penton.com
 GROUP PRODUCTION DIRECTOR: **CAREY SWEETEN** carey.sweeten@penton.com
 PLEASE SEND INSERTION ORDERS TO: orders@penton.com

CIRCULATION LIST RENTALS & CUSTOMER SERVICE

USER MARKETING DIRECTOR: **BRENDA ROODE** brenda.roode@penton.com
 USER MARKETING MANAGER: **DEBBIE BRADY** debbie.brady@penton.com
 REPRINTS: **BRETT PETILLO** F | 877.652.5295 bpetillo@wrightsmedia.com
 LIST RENTAL: SMARTREACH CLIENT SERVICES MANAGER:
JAMES ADDISON T | 212.204.4318 james.addison@penton.com
 FREE SUBSCRIPTION/STATUS OF SUBSCRIPTION/ADDRESS CHANGE/MISSING BACK ISSUES:
 OMEGA T | 847.513.6022 TOLL FREE | 866.505.7173

SALES REPRESENTATIVES

MANAGING DIRECTOR: **TRACY SMITH** T | 913.967.1324 F | 913.514.6881
tracy.smith@penton.com
PAUL MILNAMOW T | 312.840.8462 paul.milnamow@penton.com
 AZ, CA, CO, ID, MN, MT, ND, NM, NV, S/OH, OR, SD, UT, WA, WI, WY, WESTERN CANADA
RONALD KLIMKO T | 216.931.9662 ronald.klimko@penton.com
 AL, AR, CT, DE, FL, GA, IA, IN, KS, KY, LA, MA, MD, ME, MO, MS, NC, NE, NH, NJ, NY, N/OH, OK, PA, RI, SC, TN, TX, VA, VT, WV,
 EASTERN CANADA
MARTY MCCLELLAN T | 312.343.9278 marty.mcclellan@penton.com
 IL, MI
 INTERNATIONAL SALES
 ITALY: **DIEGO CASIRAGHI** T | +011.390.31.261407 F | +011.390.31.261380
diego@casiraghi-adv.com
 GERMANY, AUSTRIA, SWITZERLAND: **CHRISTIAN HOELSCHER**
 T | +011.49.89.95002778 christian.hoelscher@husonmedia.com
 BELGIUM, NETHERLANDS, LUXEMBURG, UNITED KINGDOM, SCANDINAVIA, FRANCE, SPAIN, PORTUGAL:
RACHEL DISANTO T | +011.44.1625.876622 M | +011.44.7794.366887
rachel.disanto@husonmedia.com
 PAN ASIA: **HELEN LAI** T | 866.2.2727.7799 F | 866.2.2728.3686 helen@hway.com

ONLINE

MARKETING AUTOMATION SPECIALIST: **DAN KRAFT** dan.kraft@penton.com
 PRODUCT DEVELOPMENT DIRECTOR: **RYAN MALEC** ryan.malec@penton.com
 EMEDIA CLIENT SERVICE MANAGER: **JOANN MARTIN** joann.martin@penton.com

DESIGN ENGINEERING & SOURCING GROUP

EXECUTIVE DIRECTOR OF CONTENT AND USER ENGAGEMENT: **NANCY FRIEDRICH**
 GROUP DIRECTOR OF OPERATIONS: **CHRISTINA CAVANO**
 GROUP DIRECTOR OF MARKETING: **JANE COOPER**

PENTON

1166 AVENUE OF THE AMERICAS, 10TH FLOOR
 NEW YORK, NY 10036 T | 212.204.4200



Electronic Design | Machine Design | Microdevices & RF | Source ESB | Hydraulics & Pneumatics |
 Global Purchasing | Distribution Resource | Power Electronics & Defense Electronics

PENTON IS AN INFORMA BUSINESS

Kep-O-seal®

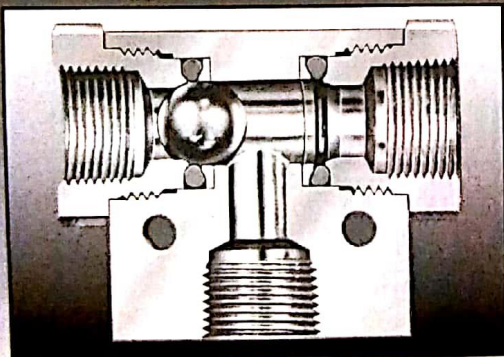

Shuttle Valves

Low switching pressures, large flow paths, solid construction and the *Flexible Seal Seat™* provide sensitivity sufficient for logic circuitry with the toughness required of rugged service and long, trouble free operation. Rated 3000 PSI in Brass, Carbon Steel and Stainless Steel. Five sizes to 3/4" NPT.

For details visit: www.kepner.com





Bring your documentation to life with a machine-specific ITM: The cutting-edge training, reference, and troubleshooting tool!

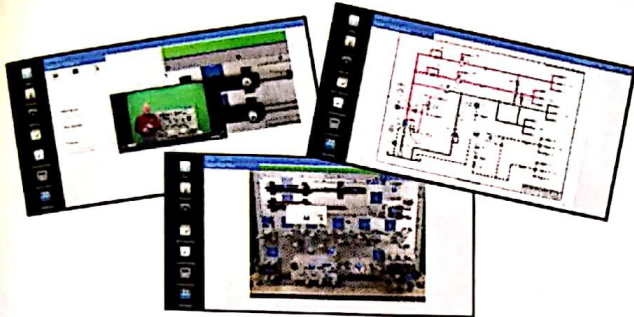

CFC INDUSTRIAL TRAINING

www.cfcindustrialtraining.com



Now Available



SC Hydraulic Engineering introduces its new portable test cart. This compact mobile design offers many popular features found on our standard power units.

SC Hydraulic's Newest Addition 90 Series Portable Test Cart

- ◆ Mobile self contained power unit
- ◆ Air operated – No electricity needed
- ◆ Pressures up to 65,000-psi with 100-psi air drive
- ◆ Available with a 5 or 10 gallon stainless steel reservoir
- ◆ Compatible with most fluids
- ◆ Available with all 10-series pumps
- ◆ Air drive controls, pressure gauges and valves included
- ◆ Used in:
 - Hydrostatic testing
 - Burst testing
 - Water-jet blasting
 - Hydraulic press operation
 - Hydraulic cylinder & valve actuation

*Contact factory for gauges over 60,000 psi

SC Hydraulic Engineering Corporation
 1130 Columbia Street . Brea, California 92821 . USA
 Phone (714) 257-4800 . Fax (714) 257-4810 . Email info@schydraulic.com
www.SCHydraulic.com

Advertisers Index

ACE CONTROLS.....	IBC	MAIN MFG. PRODUCTS	21
ACL SRL	14	MINDMAN PNEUMATICS.....	32
ADSENS TECHNOLOGY.....	17	MOCAP LLC	33
AIRTAC INTERNATIONAL GROUP	17	O'KEEFE CONTROLS, INC.....	27
AUTOMATION DIRECT	5	OP SRL	16
CFC TRAINING INSTITUE.....	39	ORANGE RESEARCH INC.....	6
C.MATIC SRL.....	8	PHD INC.....	7
CERTAGS.....	20	ROTOR CLIP CO.....	11
CLIPPARD INSTRUMENT LAB INC.....	23	SC HYDRAULICS ENGINEERING CORP.....	39
DEMAC.....	19	SPECTRONICS CORP.....	15
EATON HYDRAULICS	9	THE LEE COMPANY	31
EURAL GNUTTI SPA.....	33	TOMPKINS INDUSTRIES INC.....	IFC,21
FLOW EZY FILTERS, INC.....	4	VELJAN HYDRAIR LTD.....	1
HYDRAULICS INC	31	VEST INC	3
IKUSI.....	13	ZERO-MAX, INC.....	26
ITT CONTROL TECHNOLOGIES	25		
KEPNER PRODUCTS CO.	8		

Although every effort has been made to ensure the accuracy of this index, the publisher cannot be held responsible for any errors or omissions.